



HANSABASIC

Installation and maintenance guide



4-9



10,12,
13

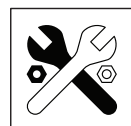

11-12



14-19



20

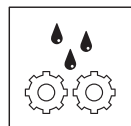

21



22



5535 0110

EN 1111, EN 1112, EN 1113
 100 - 1000 kPa
 0.18 / 0.24 l/s (300 kPa)
 max. +65°C

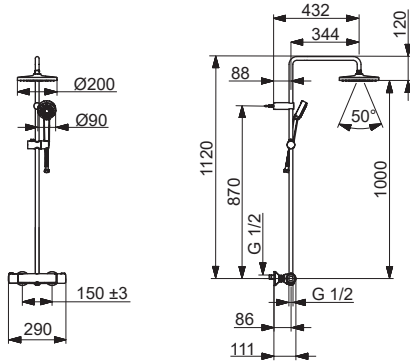

mpi.hansa.com/55350110

5516 2131

II (ISO 3822)
 EN 1111
 100 - 1000 kPa
 0.16 l/s (Eco)
 0.34 / 0.19 l/s (300 kPa)
 max. +65°C

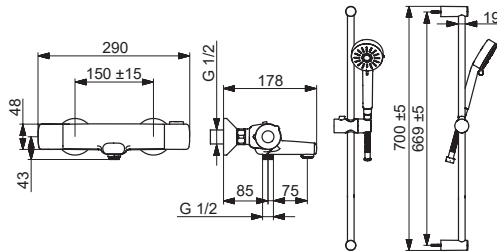

mpi.hansa.com/55162131

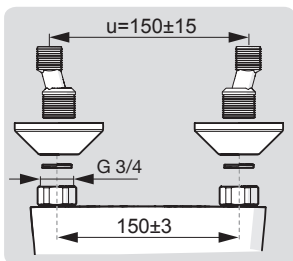
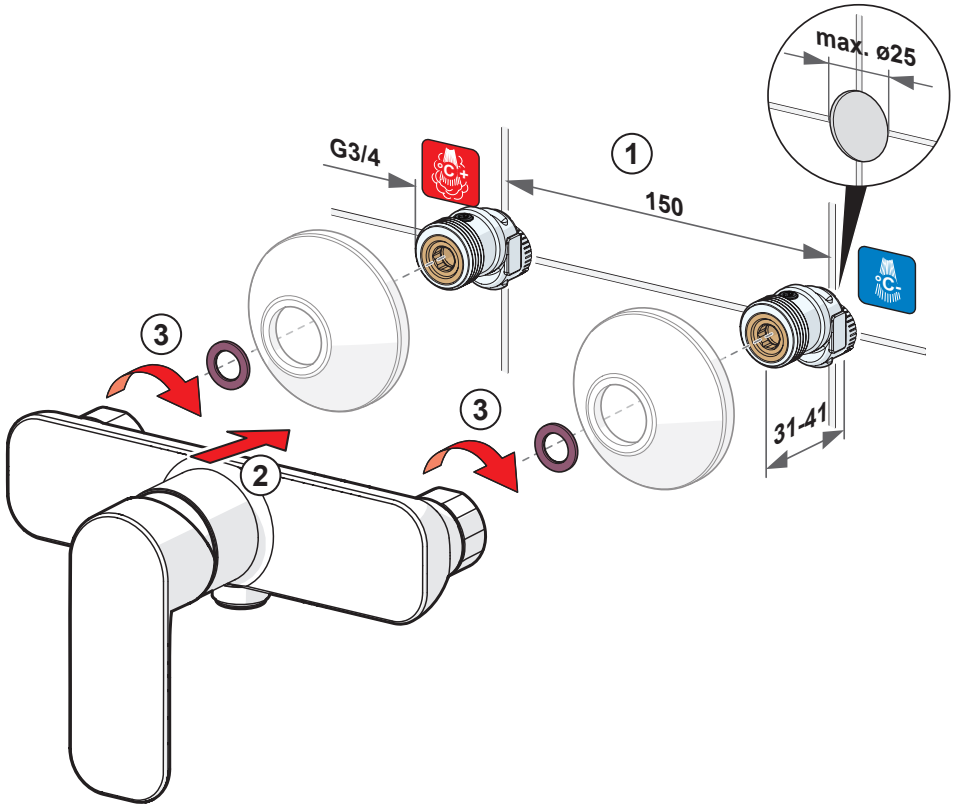
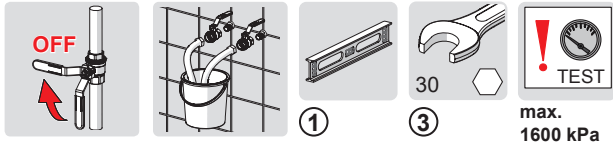



1 3

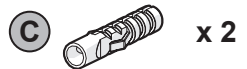
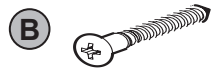
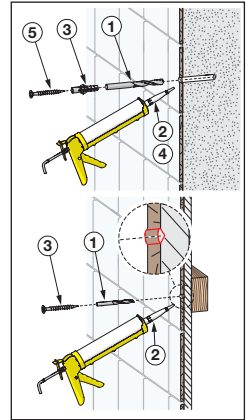
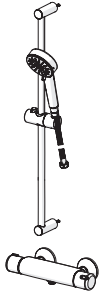
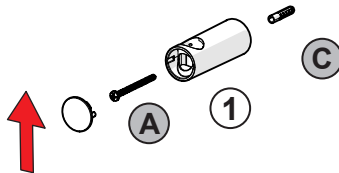
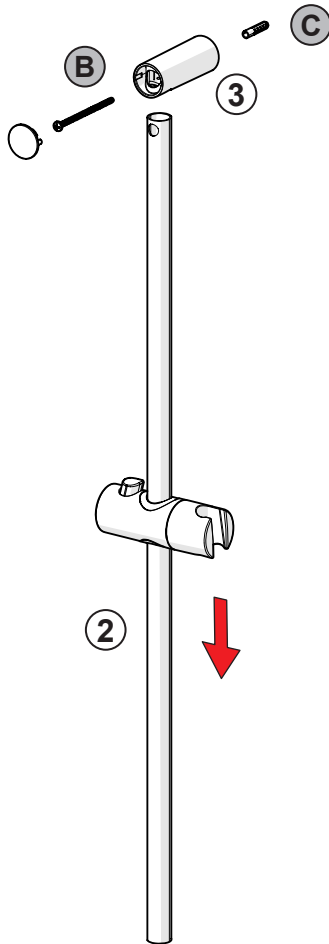
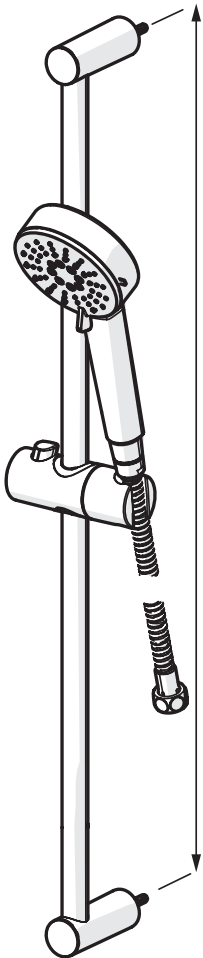

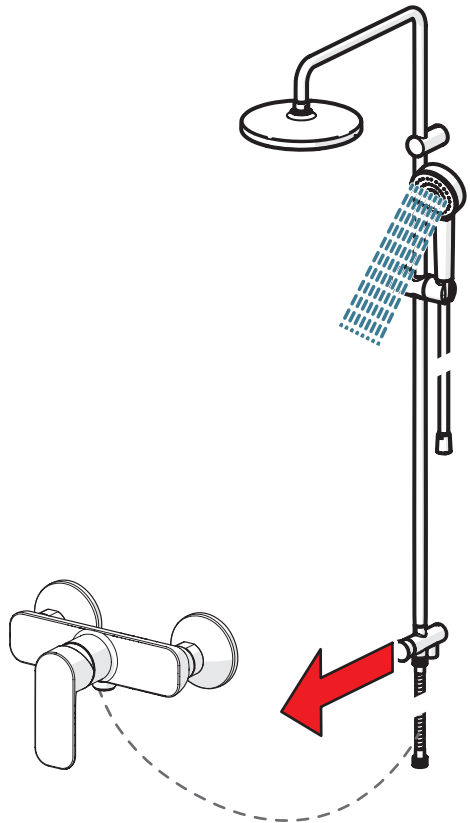
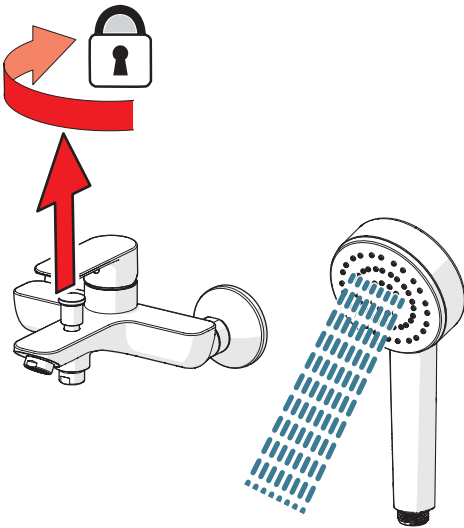
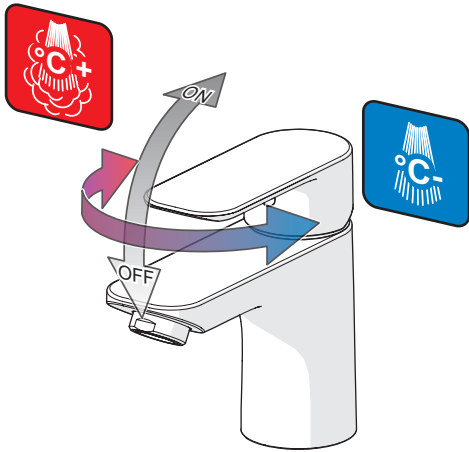

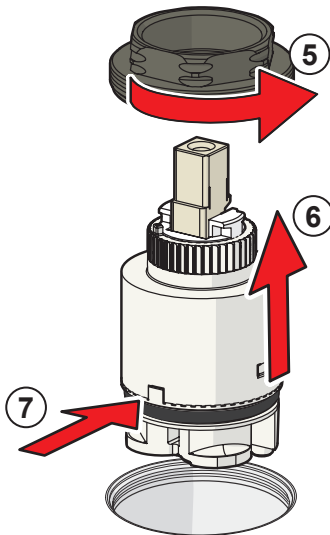
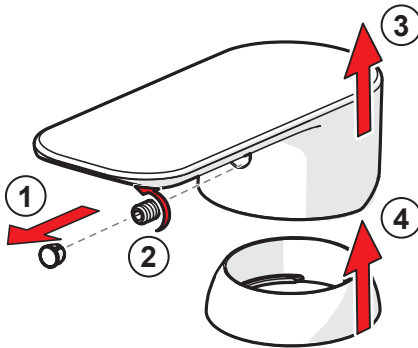
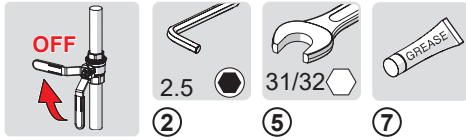
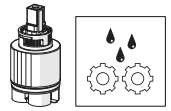

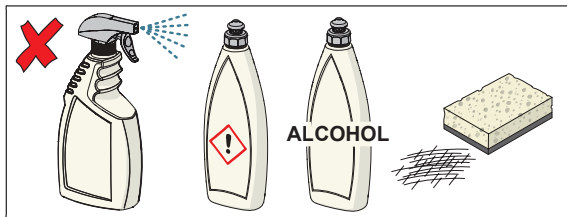
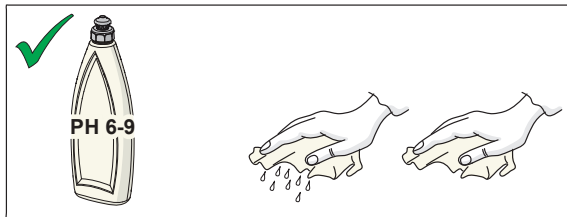
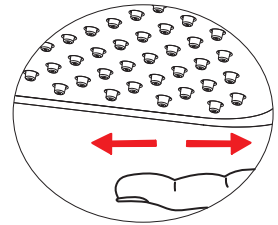
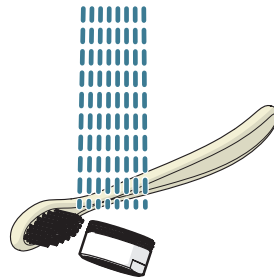
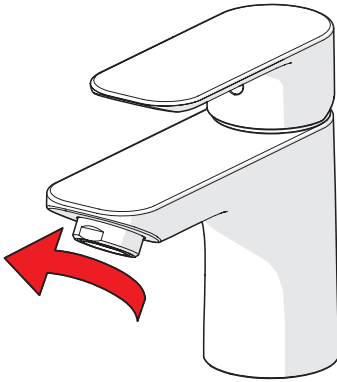
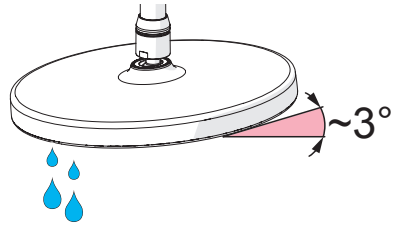

cleaning.hansa.com