

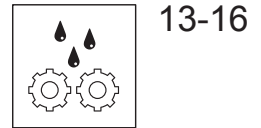

HANSASTE**LA**

Installation and maintenance guide

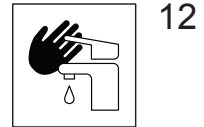



5715 2273

I (ISO 3822)
EN 817
50 - 1000 kPa
0.08 l/s (300 kPa)
max. +80°C

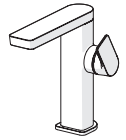
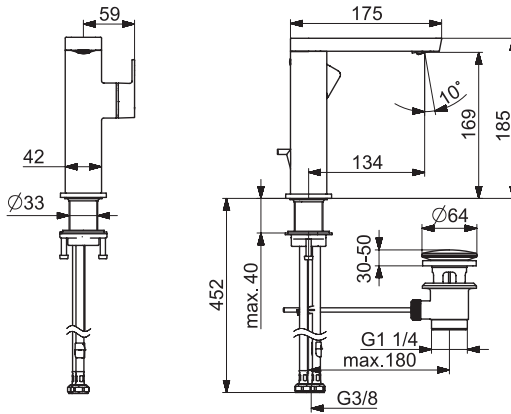

mpi.hansa.com/57152273

5767 0173

EN 817
50 - 1000 kPa
max. +80°C

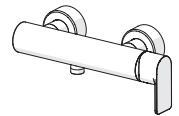
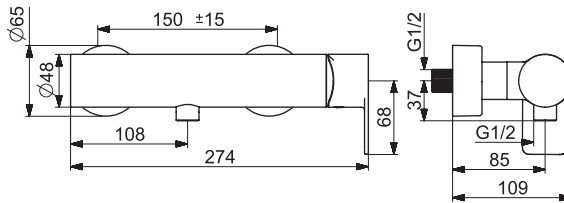

mpi.hansa.com/57670173

5774 2173

I (ISO 3822)
EN 817
50 - 1000 kPa
0.212 l/s (300 kPa)
max. +80°C

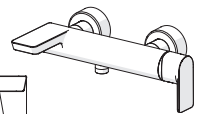
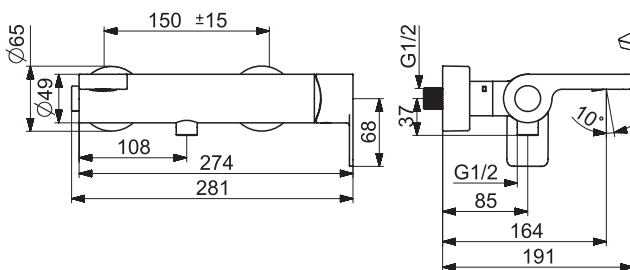

mpi.hansa.com/57742173

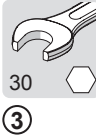
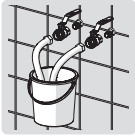
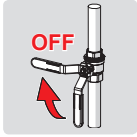

max.
1600 kPa

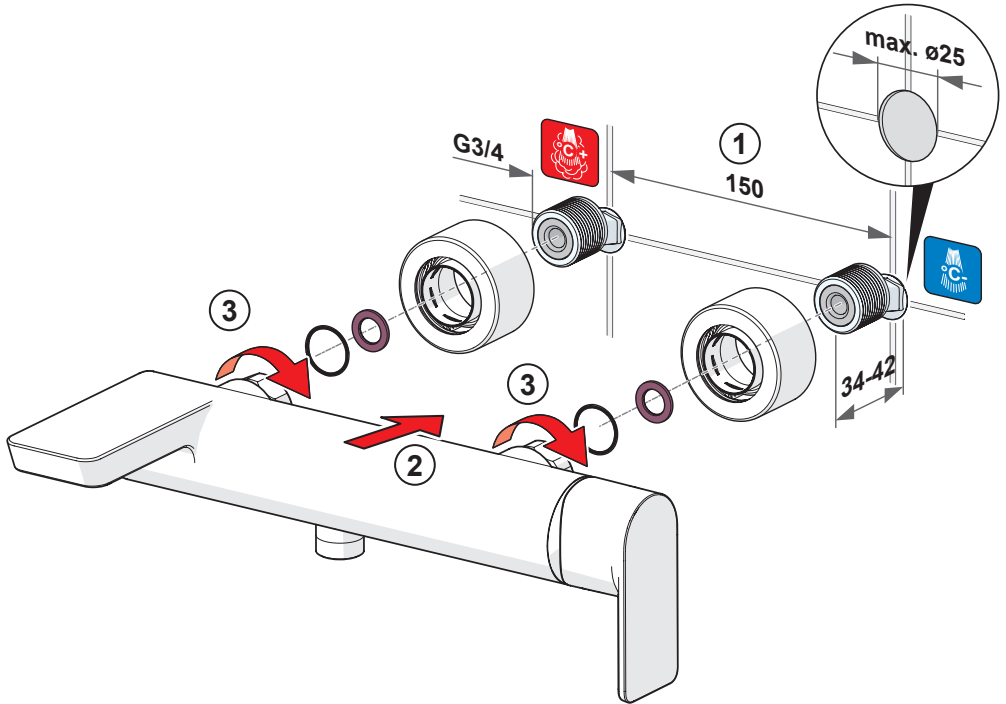

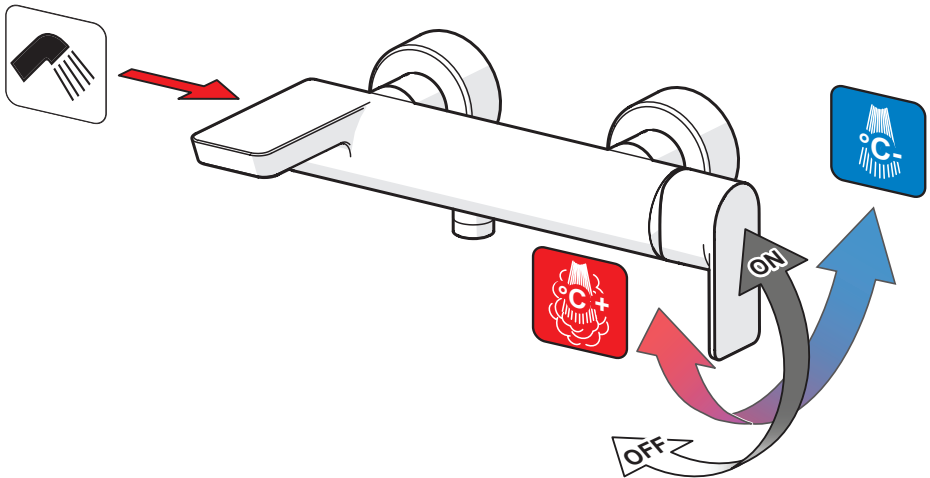
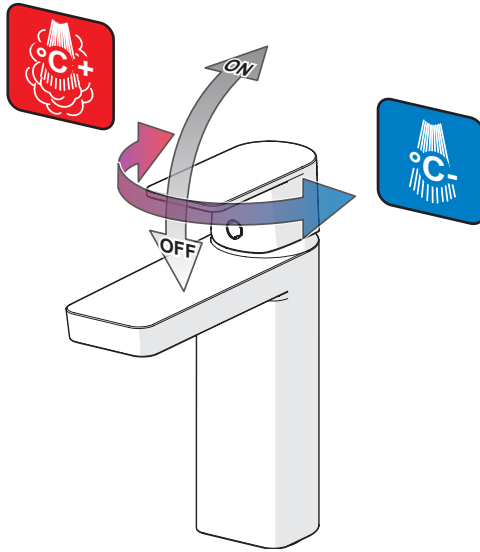

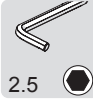

2.5

②



⑤ ⑥

